

CHAPTER 6
ALIGNMENT PROCEDURES

CONTENTS

| <u>Para.</u> | | <u>Page</u> |
|--------------|---|-------------|
| 1 | INTRODUCTION | 6-1 |
| 6 | RECEIVER DISASSEMBLY AND REASSEMBLY | 6-1 |
| 7 | CHECKING PROCEDURE, POWER SUPPLY A10 | 6-3 |
| 8 | Procedure | 6-3 |
| 9 | ALIGNMENT PROCEDURE - 2nd LO/BFO SYNTHESIZER A8 | 6-4 |
| 10 | Procedure | 6-4 |
| 11 | ALIGNMENT PROCEDURE - 1st LO SYNTHESIZER A7 | 6-5 |
| 12 | Procedure | 6-5 |
| 13 | ALIGNMENT PROCEDURE - MICROCOMPUTER A6A2 | 6-6 |
| 14 | ALIGNMENT PROCEDURE - IF/AF BOARD A4 | 6-6 |
| 15 | Procedure | 6-6 |
| 16 | ALIGNMENT PROCEDURE ISB IF/AF A5 | 6-8 |
| 17 | ALIGNMENT PROCEDURE 2nd MIXER A3 | 6-8 |
| 18 | Procedure | 6-8 |
| 19 | ALIGNMENT PROCEDURE - 1st MIXER MODULE A2 | 6-9 |
| 20 | Procedure | 6-9 |

| <u>Para.</u> | | <u>Page</u> |
|--------------|--|-------------|
| 21 | ALIGNMENT PROCEDURE - RF AMPLIFIER/LOWPASS FILTER A1 | 6-10 |
| 22 | Procedure | 6-10 |
| 23 | ALIGNMENT PROCEDURE - FRONT PANEL MODULES A9A1 AND A9A2 | 6-10 |
| 24 | FINAL GAIN AND AGC ADJUSTMENTS | 6-11 |

TABLES

| <u>Table No.</u> | | <u>Page</u> |
|------------------|-------------------------|-------------|
| 1 | Test Equipment Required | 6-2 |

ILLUSTRATIONS

| <u>Fig. No.</u> | |
|-----------------|---|
| 6.1 | Top View, RA1792 Receiver |
| 6.2 | Bottom View, RA1792 Receiver |
| 6.3 | Component Layout: RF Amplifier/LPF Board A1 |
| 6.4 | Component Layout: First Mixer Board A2 |
| 6.5 | Component Layout: Second Mixer Board A3 |
| 6.6 | Component Layout: Main IF/AF Board A4 |
| 6.7 | Component Layout: Microcomputer Board A6A2 |
| 6.8 | Component Layout: First LO Synthesizer A7 |
| 6.9 | Component Layout: Second LO/BFO Synthesizer A8 |
| 6.10 | Component Layout: Front Panel Switch & Display Board A9A1 |
| 6.11 | Component Layout: Front Panel Memory Board A9A2 |
| 6.12 | Component Layout: AC Power Supply Module A10 |

CHAPTER 6

ALIGNMENT PROCEDURES

INTRODUCTION

- 1 This chapter contains alignment procedures for the RA1792 Receiver as a complete assembly. Under normal operating conditions the receiver will maintain the factory alignment over a long period of time. Realignment should, therefore, only be carried out following the replacement of components which affect the alignment, or where a known misalignment exists. Refer to Chapter 3, Operation, for operating instructions.
- 2 Should it be necessary to realign the complete receiver, the following procedures must be followed in the order given. Before attempting to realign an individual sub-assembly it must be ascertained, where applicable, that the preceding assemblies are functioning correctly.
- 3 If the specified performance cannot be attained by alignment, then a fault must be suspected and reference should be made to Chapter 5, Fault Finding.
- 4 A certain amount of dismantling is necessary to gain access to certain areas of the receiver. Details for dismantling and reassembly are contained in paragraph 6. After alignment, ensure that all dismantled assemblies are correctly reassembled and that all shielding covers are replaced using all screws provided or their exact equivalents.
- 5 Table 6-1 lists the test equipment required. Those listed in the example column are recommendations only. Any instruments with equal or better characteristics may be substituted.

RECEIVER DISASSEMBLY AND REASSEMBLY

- 6 Figures 6.1 and 6.2 show the location of the printed circuit boards, and Figures 6.3 to 6.12 show the location of components on the printed circuit cards.

To disassemble the receiver proceed as follows:

- (1) Remove the receiver from rack or cabinet. It is held by 4 screws on the front panel.
- (2) Remove top and bottom cover plates by loosening six quarter-turn fasteners.

TABLE 6-1

TEST EQUIPMENT

| Item | Instrument | Specification | Recommended Instrument |
|------|-----------------------------|---|------------------------|
| 1 | Digital Multimeter | Range: 0 to 150V a.c. and d.c. 0 to 1A a.c. and d.c. Display: 3½ digits Accuracy: ± 3% | Racal 4002 |
| 2 | Oscilloscope, Dual Trace | Sensitivity: 5 mV/div. Frequency: d.c. to 2 MHz | Tektronix 465 |
| 3 | RF Voltmeter | Range: 300 mV to 3V r.m.s. Frequency: 100 kHz to 70 MHz Input Impedance: > 1 M ohm with 50 ohm adaptor Accuracy: ± 1% of full scale | Racal 9301A |
| 4 | Audio output power meter | 1 mW - 1W 15Ω and 600Ω | Marconi TF893B |
| 5 | Digital Frequency Meter | Frequency Range: 0 to 50 MHz Sensitivity: 10 mV r.m.s. Impedance: 1 M ohm Accuracy: 1 part in 10 ⁶ ± 1 count | Racal 9904 |
| 6 | Signal Generator | Frequency Range: 450 kHz to 50 MHz Accuracy and Stability: Output frequency is locked to the frequency standard in use. Output Level Range: -130 dBm to +13 dBm into 50Ω Modulation: AM 800 mV into 600Ω gives 80% mod. depth. FM 1V into 600Ω gives peak selected deviation. Peak deviation is between 10 kHz and 300 kHz depending on selected range. Output Impedance: 50Ω | Racal 9084 |
| 7 | Terminating Coupler | 50-ohm BNC-SMB | |

- (3) The A1, A6A1 and A6A2 modules may now be removed from the chassis by unplugging all electrical connections, removing the screws securing each module, then lifting the module away from the chassis.
- (4) The Power Supply module (A10) may be removed by disconnecting electrical connections, loosening the 4 captive screws, holding the module to the chassis, and 5 screws securing the module to the rear panel.
- (5) To remove A4 and/or A5 (optional) modules, unplug all electrical connections, remove screws securing the module to the chassis and lift the module out.
- (6) To remove either A9A1 or A9A2 modules, remove the five electrical connections from A9A2 that come from modules A6A2, A4, A7, A8 and A10, then remove four screws securing the front panel and front chassis and lower the whole assembly away from the main chassis. Remove the tuning disk from the tuning shaft, located behind module A9A2. Module A9A2 may now be removed by removing the screws securing it to module A9A1.
- (7) To remove module A9A1 first perform step 6 above, then remove the IF GAIN and VOLUME control knobs and remove the front panel. The A9A1 module may now be removed from the front chassis plate by removing the screws securing it to that plate.
- (8) Figure 6-2 shows a bottom view of the chassis which provides access to modules A2, A3, A7 and A8. To remove either of these four modules, remove the shielding cover from the respective module compartment, remove its electrical connections and then remove the module by removing the screws securing it to the chassis.

CHECKING PROCEDURE, POWER SUPPLY A10

- 7 Test Equipment Required: Digital Multimeter, item 1 of Table 6-1; and Oscilloscope, item 2.

Procedure

- 8 (1) Disconnect the cable from A10J3 located on the base of the power supply.
- (2) Connect the digital voltmeter, item 1, between chassis (0V) and each of the following pins of the power supply, A10, in turn. Use the oscilloscope, item 2, to measure the a.c. ripple.

| A10A1J1 Pin No's | Voltage | AC Ripple (p-p) |
|------------------|--------------------------|-----------------|
| 1, 14 | +20V, $\pm 1V$ | 5 mV |
| 10, 11, 24 | +15, $\pm 0.75V$ | 5 mV |
| 3, 16 | +20V nominal unregulated | |
| 22, 23 | -15V, $\pm 0.75V$ | 5 mV |
| 7, 8 | +12V, $\pm 0.5V$ | 5 mV |
| 4, 17 | +5V, +0.5, - 0.2V | 5 mV |
| 5, 18 | +10V nominal unregulated | 5 mV |
| 13, 19, 20 | Ground, 0 Volts | |

(3) Disconnect all test equipment and reconnect the cable to the power supply.

ALIGNMENT PROCEDURE - 2nd LO/BFO SYNTHESIZER A8

9 Test Equipment Required: Digital Multimeter, item 1 of Table 6-1, RF Voltmeter, item 3, Digital Frequency Meter, item 5, and Oscilloscope, item 2.

Procedure

10 (1) Check on the A8 board to ensure that the links LK1 and LK2 are made in accordance with Table 6-2 for the required REF Frequency IN/OUT mode of operation.

TABLE 6-2

| Operating I/O | LK1 | LK2 |
|---------------|------|------|
| 1 MHz | Link | Link |
| 5 MHz | Open | Link |
| 10 MHz | Link | Open |

- (2) Check that S2 REF INT/EXT switch on the rear panel is set to INT.
- (3) Connect the digital frequency meter to J3 and the digital multimeter, set to the 10 Volt range, between TP5 and ground. Connect the frequency counter 1 MHz input to the receiver REF IN/OUT socket J1.
- (4) Check Voltmeter for a reading between 6 to 11 Volts. Check frequency counter for a reading of 40.000000 MHz ± 1 Hz.
- (5) Disconnect the frequency meter and measure the 40 MHz output level at J3 into 50 ohms, using the RF Voltmeter. This level should be not less than -5 dBm.
- (6) Set the receiver controls for CW operation, BFO centre, and BFO indication to 0.00 kHz.

- (7) Connect the digital frequency meter to J4 on the digital multimeter, set to the 10 Volt range, between TP8 and ground.
- (8) Observe that the BFO output is $455,000 \pm 1$ Hz then adjust the tuning slug of L4 as necessary for a multimeter indication of 8 ± 0.5 volts.
- (9) Select BFO variable and tune the BFO using the front panel control. Observe that the frequency meter agrees with the front panel indications.
- (10) Typical frequencies, signal levels and voltages as they should be at various test points are shown below. When measuring at TP2 and J1, set INT/EXT switch to INT and links LK1 and LK2 are connected for 1 MHz I/O at J1.

| Test Point | Frequency | Volts | Remarks |
|------------|-----------|----------------|---|
| TP2 | 5 MHz | TTL | Use oscilloscope |
| TP5 | DC | $5.5 \pm 2.5V$ | Use multimeter |
| TP8 | DC | $8 \pm 2V$ | Use multimeter |
| TP9 | 22.75 MHz | 200 mV min p-p | Use oscilloscope (BFO set to 0.00 kHz) |
| TP10 | 5 MHz | 1V min p-p | Use oscilloscope |
| J1 | 1 MHz | 222 mV min | Use RF voltmeter |
| J2 | 1 MHz | TTL | Use oscilloscope |
| J4 | 455 kHz | 0.7V p-p | Use oscilloscope |

ALIGNMENT PROCEDURE - 1st LO SYNTHESIZER A7

- 11 Test equipment required: Digital Multimeter, item 1 of Table 6-1, Oscilloscope with X1 probe: item 2, Digital Frequency Meter, item 5.

Procedure

- 12
- (1) Connect the digital multimeter between TP5 and ground.
 - (2) Set R17 for a multimeter indication of 5.2 ± 0.01 Volts.
 - (3) Connect the multimeter between TP11 and ground.
 - (4) Tune the receiver to 29.99999 MHz, and adjust L5 for a multimeter indication of 14 Volts.
 - (5) Tune the receiver to 00.00000 MHz and ensure that the multimeter indication is not less than 2.5V.
 - (6) Set the receiver tune frequency to 1046 kHz. Set the oscilloscope to display 0.2 ms/div., external trigger. Trigger the scope from the signal on TP4 and connect the X1 oscilloscope probe to TP11. Set the vertical sensitivity to 5 mV/div.

- (7) Adjust R4 to null out the signal on the oscilloscope.
- (8) Connect the digital frequency meter to 1st LO output at A7 J3.
- (9) Observe that the indicated frequency is equal to the receiver tuned frequency plus 40.455 MHz (± instrument error) over the full receiver tuning range.
- (10) Disconnect all test equipment and re-connect all module interconnections.

ALIGNMENT PROCEDURE - MICROCOMPUTER A6A2

- 13 No adjustments are provided on the A6A2 module and alignment is not required. A6A2 clock frequency is 2 MHz nominal.

ALIGNMENT PROCEDURE - IF/AF BOARD A4

- 14 Test equipment required: Digital Multimeter, item 1 of Table 6-1, RF Voltmeter item 3, Audio Power Meter, item 4, Digital Frequency Meter, item 5, Signal Generator, item 6 and 50 ohm terminating coupler, item 7.

Procedure

- 15 (1) Connect the Digital Multimeter between TP9 and ground and select AGC SHORT on the front panel of the receiver. With no signal at antenna input adjust R119 for a multimeter reading of 10 ± 0.05 Volts.
- (2) Set the AGC to MAN. and turn the IF GAIN control fully clockwise. Select CW BW5 (16 kHz).
- (3) Connect the signal generator output to A4J1. Set the signal generator to 455.00 kHz and the output level to 250 μ V pd.
- (4) Connect the RF voltmeter with 50 ohm termination to the IF OUT socket, J2 on the rear panel.
- (5) Adjust L1 and L2 for maximum indication on the RF voltmeter.
- (6) Connect the RF Voltmeter, using the high impedance probe, to A4TP7.
- (7) With IF GAIN at maximum, bandwidth to 3 kHz, adjust R39 on the A4 board for an indicated 300mV rms ± 1 dB on the RF Voltmeter.
- (8) Set the AGC to SHORT. Increase the signal generator level by 35 dB and adjust R47 for $8.5V \pm 0.05V$ on TP9 measured with the digital multimeter.

- (9) Connect the RF Voltmeter to the rear panel IF OUT socket, J2. Select AGC MAN, 6 kHz BW. Adjust the IF GAIN control for 100 mV on the RF voltmeter.
- (10) Select each bandpass filter in turn and verify that the required 6 dB bandwidths are obtained by tuning the signal generator through the receiver pass-band.

TABLE 6-3

6 dB BW (min)

| | | |
|-----|---------|--|
| BW1 | 0.3 kHz | |
| BW2 | 1.0 kHz | |
| BW3 | 3.2 kHz | |
| BW4 | 6.0 kHz | |
| | USB/LSB | -6 dB max, 250 Hz to 3.2 kHz in wanted sideband. |
| BW5 | 16 kHz | |

NOTE: 1. LSB should be measured at A5J3 if ISB of A5 is fitted.

2. The 6 dB bandwidths may differ from those listed above if optional filters are fitted.

- (11) Connect the audio power meter, set to 600 ohms, to the MONITOR LINE OUT, pins 4 and 17 of J3 on the rear panel.
- (12) Set the receiver AGC to SHORT, MODE to CW, BFO 1 kHz offset.
- (13) Connect the signal generator to the A4 IF input using the BNC adaptor.
- (14) Set the signal generator to 455 kHz CW output at a level of 10 mV pd.
- (15) Adjust AF LINE LEVEL preset control R129 on A4 for 1 mW output. (.775V in 600 ohms).
- (16) Select AM mode and 6 kHz bandwidth.
- (17) Connect the audio voltmeter to LINE OUT pins 1 and 14 on J3 on the rear panel. Modulate the signal generator to 30% at 1 kHz and check for audio output indication on the Audio Voltmeter.
- (18) Select FM mode and 16 kHz bandwidth.
- (19) Modulate the signal generator frequency at a 1 kHz rate with a peak deviation of 5.6 kHz.

- (20) Peak L3 for maximum AF output.
- (21) Connect the output power meter set to 15Ω to the output terminals of J3.
- (22) Set the VOLUME control on the front panel to maximum. Ensure that the indicated AF output level is at least 200 mW into 15 ohms.
- (23) Disconnect all test equipment, reconnect all removed module interconnections.

ALIGNMENT PROCEDURE ISB IF/AF A5

- 16 The circuits employed in A5 are identical to the relevant circuits of A4. Refer to the alignment procedures of A4 for realignment of this module.

ALIGNMENT PROCEDURE 2nd MIXER A3

- 17 Test equipment required: Digital multimeter, item 1 of Table 6-1, Signal Generator, item 6, RF voltmeter, item 3.

Procedure

- 18
- (1) Set the receiver controls for AM reception, 16 kHz bandwidth, AGC manual, and IF GAIN maximum.
 - (2) Connect the RF voltmeter to the IF OUT connector J2 on the receiver rear panel.
 - (3) Disconnect P1 from A2J3. Set R24 on the A3 board fully clockwise.
 - (4) Using the Signal Generator inject a 40.455 MHz signal to P1 and adjust the level to produce an IF output indication of 100 mV rms.
 - (5) Adjust the following trimmers in the order shown for peak output indication on the RF voltmeter, reducing the signal generator level as required to maintain the 100 mV output reference. Adjust L7, L6, L5, L4, and T1 for peak.
 - (6) With the signal generator input level of 1 μ V emf at the A3 input, the signal plus noise to noise ratio at the audio output in a 3 kHz bandwidth should be at least 18 dB.
 - (7) Remove all test equipment and re-instate all module connections.

ALIGNMENT PROCEDURE - 1st MIXER MODULE A2

19 Test equipment required: RF Voltmeter, item 3 of Table 6-1 and Signal Generator, item 6.

Procedure

- 20
- (1) Remove the local oscillator input to J1 of A2.
 - (2) Connect the signal generator to the LO input A2J1. Set the output to about 0 dBm.
 - (3) Connect the RF voltmeter using the high impedance probe to TP2 of A2.
 - (4) Set the receiver front panel controls to AM mode, AGC MAN, 16 kHz BW and IF GAIN to maximum.
 - (5) Turn SUPPLY switch to ON.
 - (6) Tune the signal generator to 17.6 MHz. Adjust coil L3 of A2 to provide a notch (minimum amplitude) at 17.6 MHz while observing the RF voltmeter indication.
 - (7) Tune the signal generator to 26.045 MHz. Adjust coil L4 in the same manner except to provide a notch at 26.045 MHz.
 - (8) Disconnect the signal generator from J1 and connect it to P1 (RF INPUT).
 - (9) Connect the RF voltmeter with the high impedance probe to the links between E3 and E5.
 - (10) Set the generator to 50.2 MHz. Adjust L5 for minimum level indication on the RF voltmeter.
 - (11) Set the generator to 40.45 MHz. Adjust L2 for minimum level indication on the RF voltmeter.
 - (12) Reconnect input cable P1 to chassis. Reconnect the LO input to J1.
 - (13) Set the receiver frequency to 2.00000 MHz.
 - (14) Connect the output of the signal generator to the chassis-mounted first mixer input coax connector. Set the signal generator frequency to 2.000 MHz and output level to 1 μ V emf.

- (15) Connect the RF voltmeter, with the 50 ohms input impedance adapter, to the IF OUT connector, J2 on the rear panel. Select CW, 3 kHz bandwidth, MAN. Turn IF GAIN control fully clockwise.
- (16) Tune the signal generator to maximum output, as indicated on the RF voltmeter. Peak T5 for maximum output.
- (17) With the signal generator input level of 1 μ V emf at the A2 input the signal plus noise to noise ratio at the audio output in a 3 kHz bandwidth should be at least 10 dB and frequencies between 500 kHz and 30 MHz.
- (18) Set the receiver supply switch to off. Disconnect all test equipment. Re-instate all module connections.

ALIGNMENT PROCEDURE - RF AMPLIFIER/LOWPASS FILTER A1

- 21 Signal generator, item 6; RF voltmeter, item 3.

NOTE: Do not attempt to align the four-section low pass filter without a spectrum analyser/tracking generator. The alignment details are shown on Fig. 8-1.

Procedure

- 22
- (1) Connect the signal generator to the antenna input socket A1 J1 and the RF voltmeter with 50 ohm termination to the RF out connector W2P1. Set the signal generator level to -10 dBm.
 - (2) If the RF amplifier is linked out ensure that the loss through the A1 module does not exceed 1.5 dB from 500 kHz to 30 MHz.
 - (3) If the RF amplifier is linked in ensure that the gain through the A1 module is 8 dB \pm 2 dB from 500 kHz to 30 MHz.
 - (4) Reconnect W2P1 to chassis connector J5.
 - (5) With a signal generator input level of 1 μ V emf at the A1 input the signal plus noise to noise ratio at the audio output in a 3 kHz bandwidth should be at least 10 dB with the RF amplifier linked out and at least 15 dB with it linked in.

ALIGNMENT PROCEDURE - FRONT PANEL MODULES A9A1 AND A9A2

- 23 No adjustments are provided on either the A9A1 or A9A2 modules and alignment is not required.

FINAL GAIN AND AGC ADJUSTMENTS

- 24 Following the adjustment or replacement of the A1, A2, A3, A4 or A5 modules the following final gain and agc adjustments should be made.
- (1) Connect the signal generator to the antenna input A1J1 and set the frequency to 1.02 MHz.
 - (2) Connect the audio power meter to the MONITOR line output, J3 pins 4 and 17. Connect the dvm to DIV AGC output, J3, pins 21 and 9. Set R105 on A4 fully clockwise.
 - (3) Set the receiver to USB, agc short and tune it to the signal generator. Set the signal generator level to 60 μ V emf. Adjust R129 on A4 for 0 dBm output on the power meter.
 - (4) Reduce signal generator level to 1 μ V emf, select MAN. and IF GAIN fully clockwise and adjust R39 on A4 for 0 dBm on the power meter.
 - (5) Select AGC SHORT and increase the signal generator level to 60 μ V emf. Adjust R47 on A4 for an indication of $8.5 \pm 0.05V$ on the dvm.
 - (6) Connect the RF voltmeter with high impedance probe to TPI on A4 board. Note the level on the RF voltmeter and slowly turn R105 on A4 anti-clockwise until this level is reduced by 1 dB.
- 25 If the receiver is fitted with the ISB option the following adjustments should be made.
- (1) Connect the dvm to the ISB DIV AGC output, J3 pins 22 and 9.
 - (2) Set the receiver to LSB, agc SHORT and tune it to the signal generator. Set the signal generator output level to 60 μ V emf. Adjust R132 on A4 for 0 dBm output on the power meter.
 - (3) Reduce the signal generator level to 1 μ V emf, select MAN. and set the IF GAIN control fully clockwise. Adjust R19 on A5 for 0 dBm on the power meter.
 - (4) Select AGC SHORT and increase the signal generator level to 60 μ V emf. Adjust R23 on A5 for an indication of $8.5 \pm 0.05V$ on the dvm.

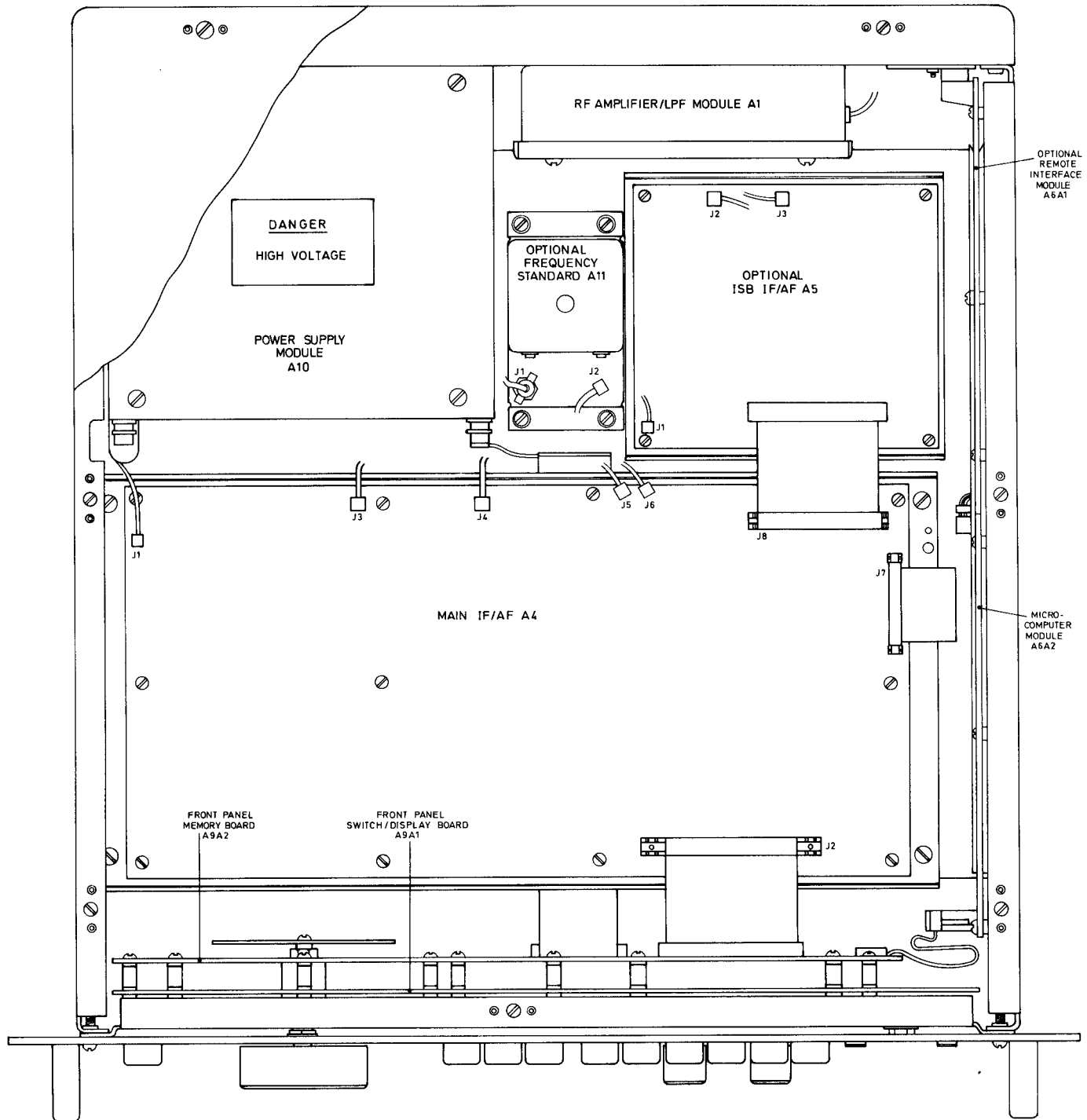

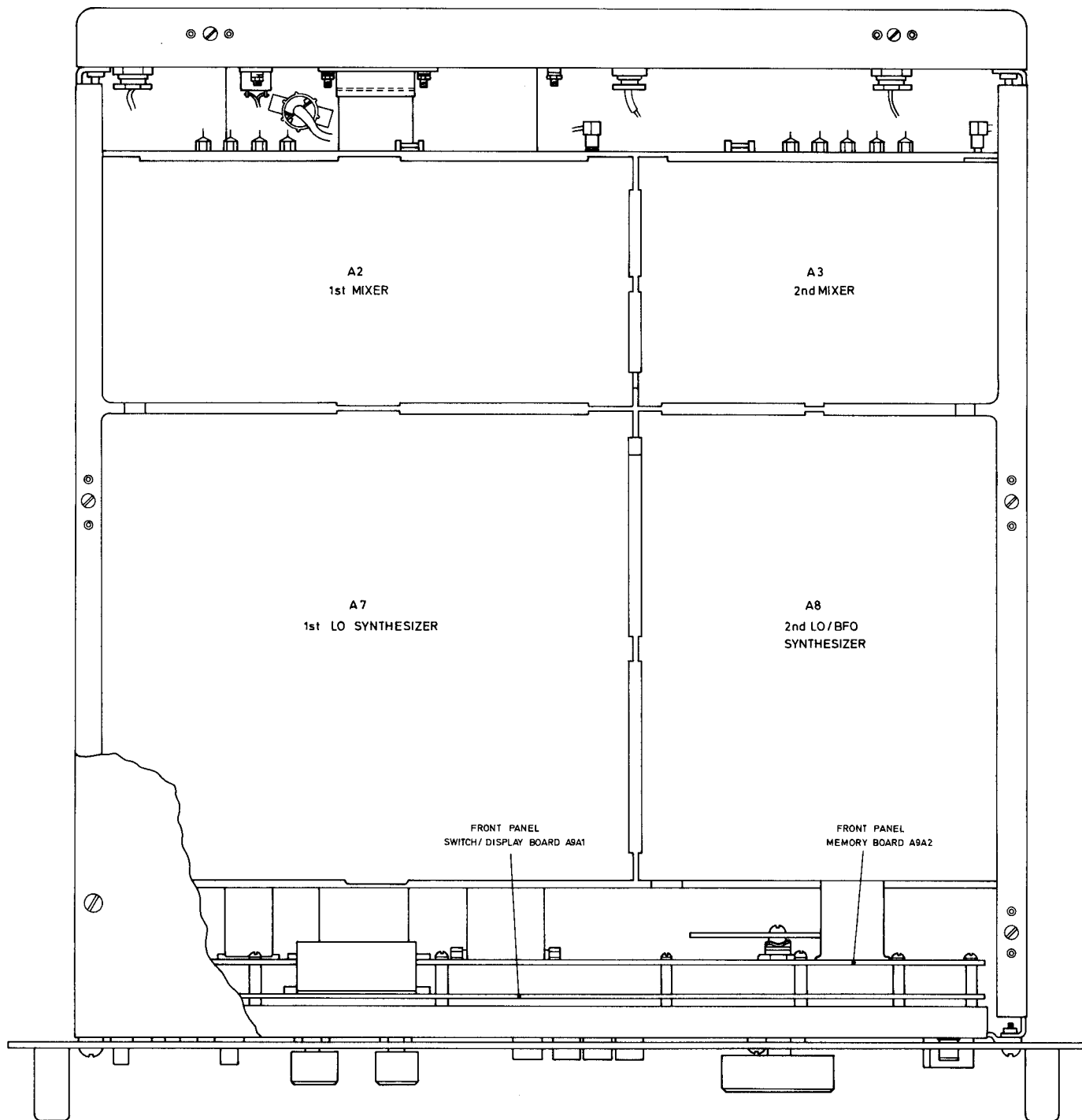

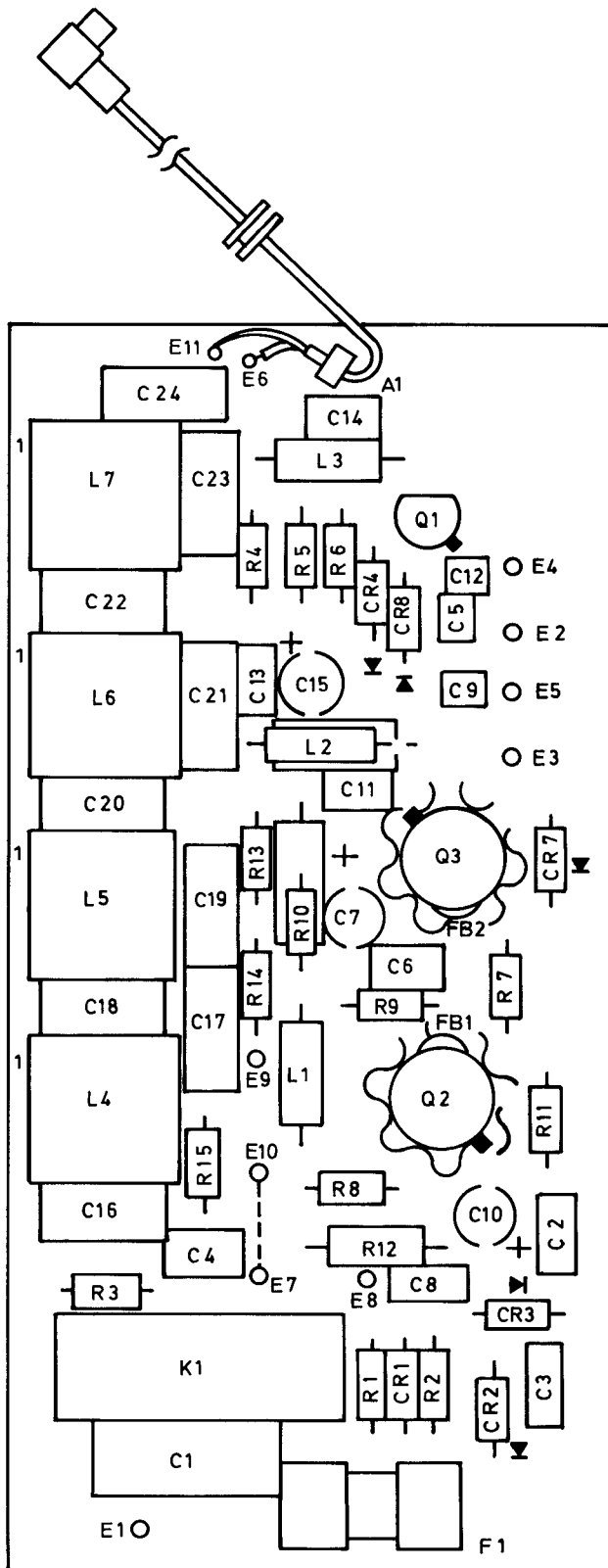

Component Layout: RF Amplifier /
 Low Pass Filter Board A1

Fig.6.3

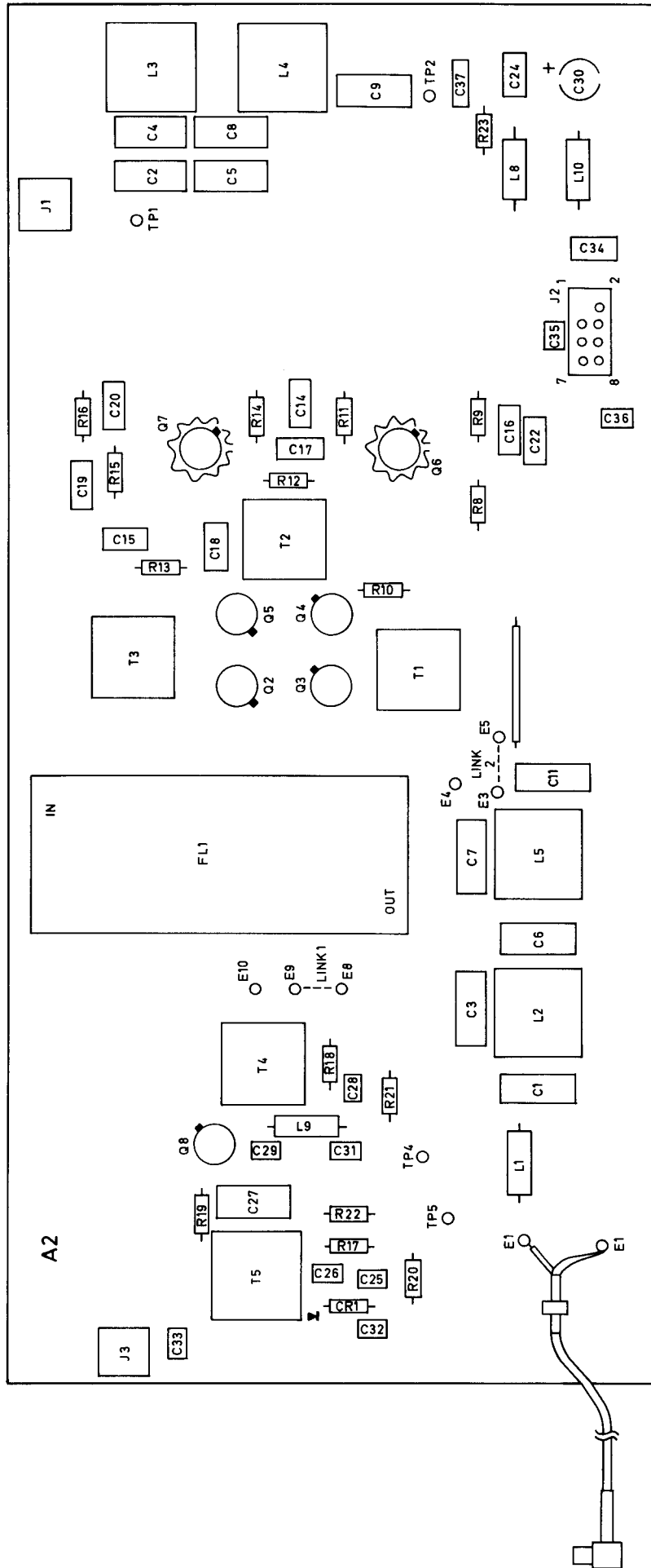

Component Layout: First Mixer Board, A2

Fig.6.4

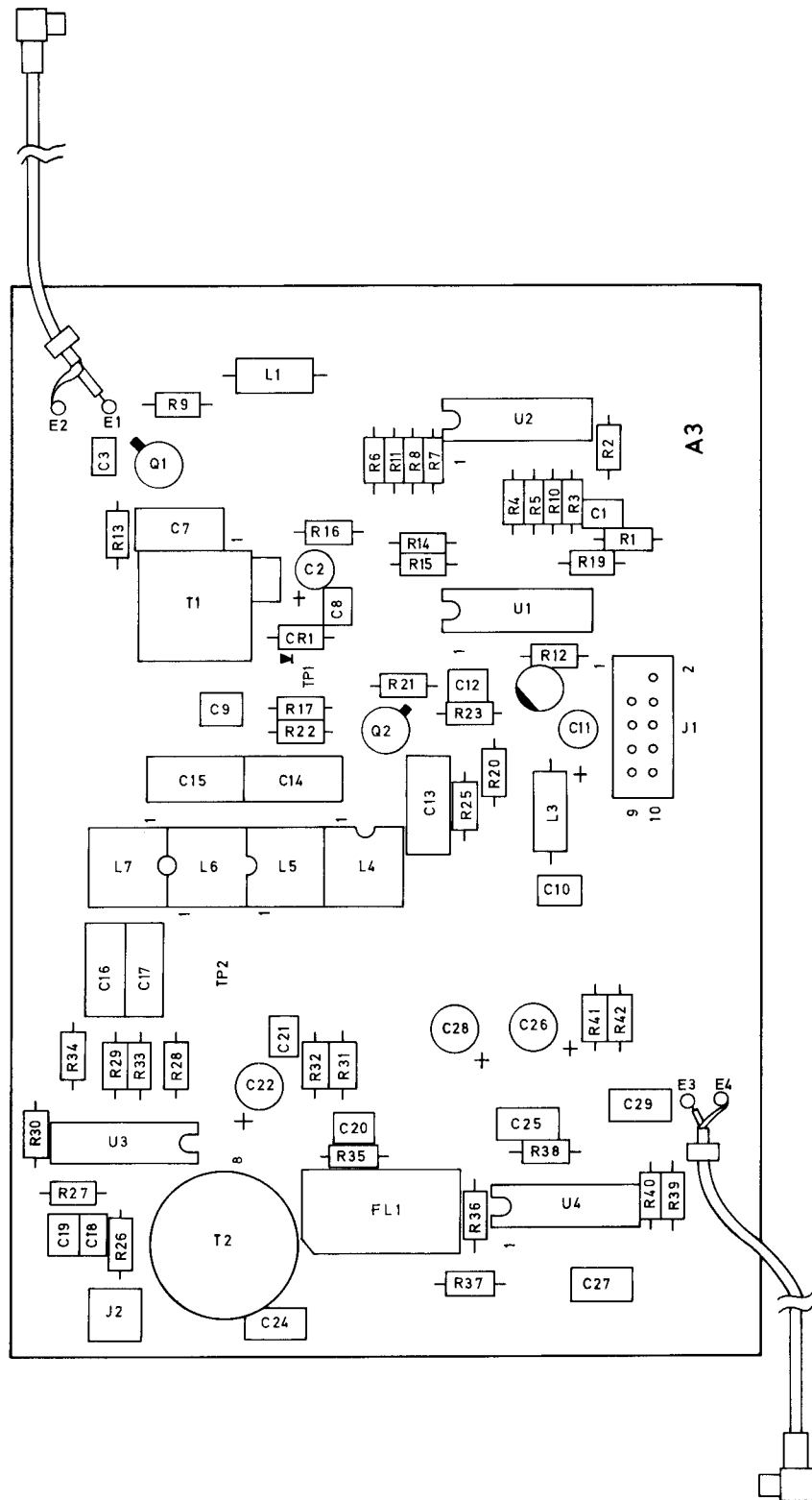

RACAL
 TH1496 DO8093
 1

Component Layout : Second Mixer Board , A3

Fig.6.5

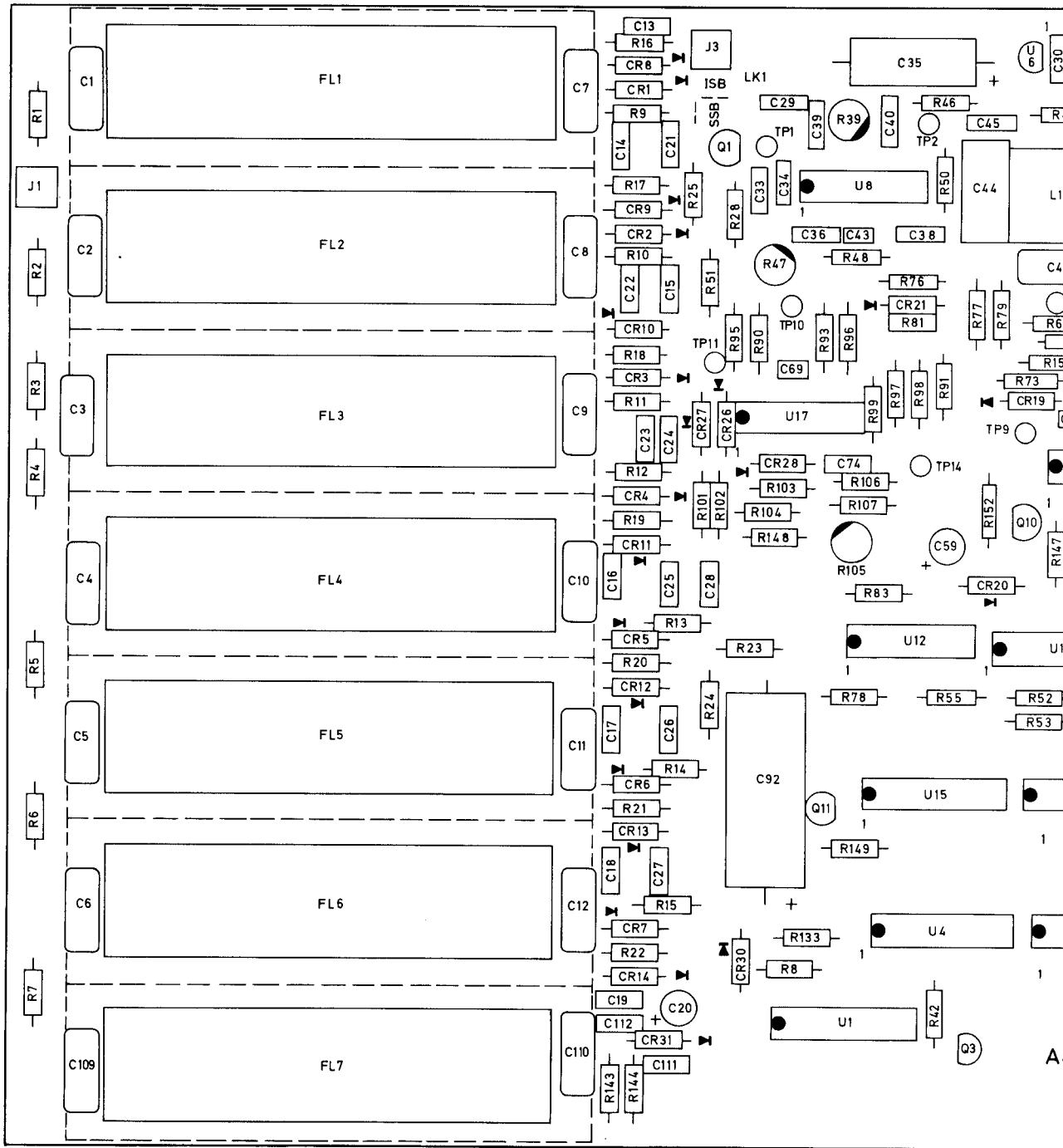

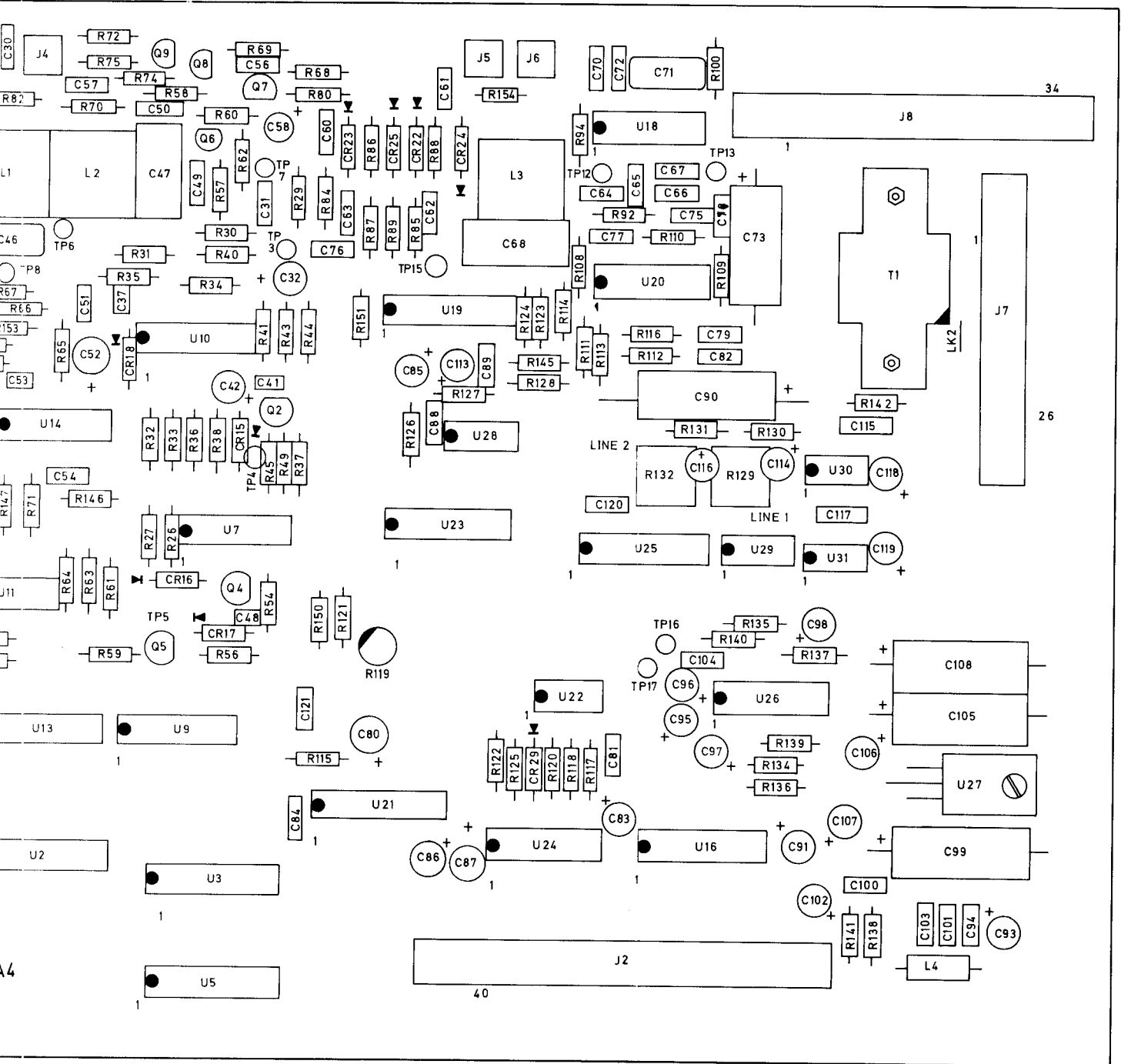

Component Layout :
Main IF/AF Board A4

Fig 6.6

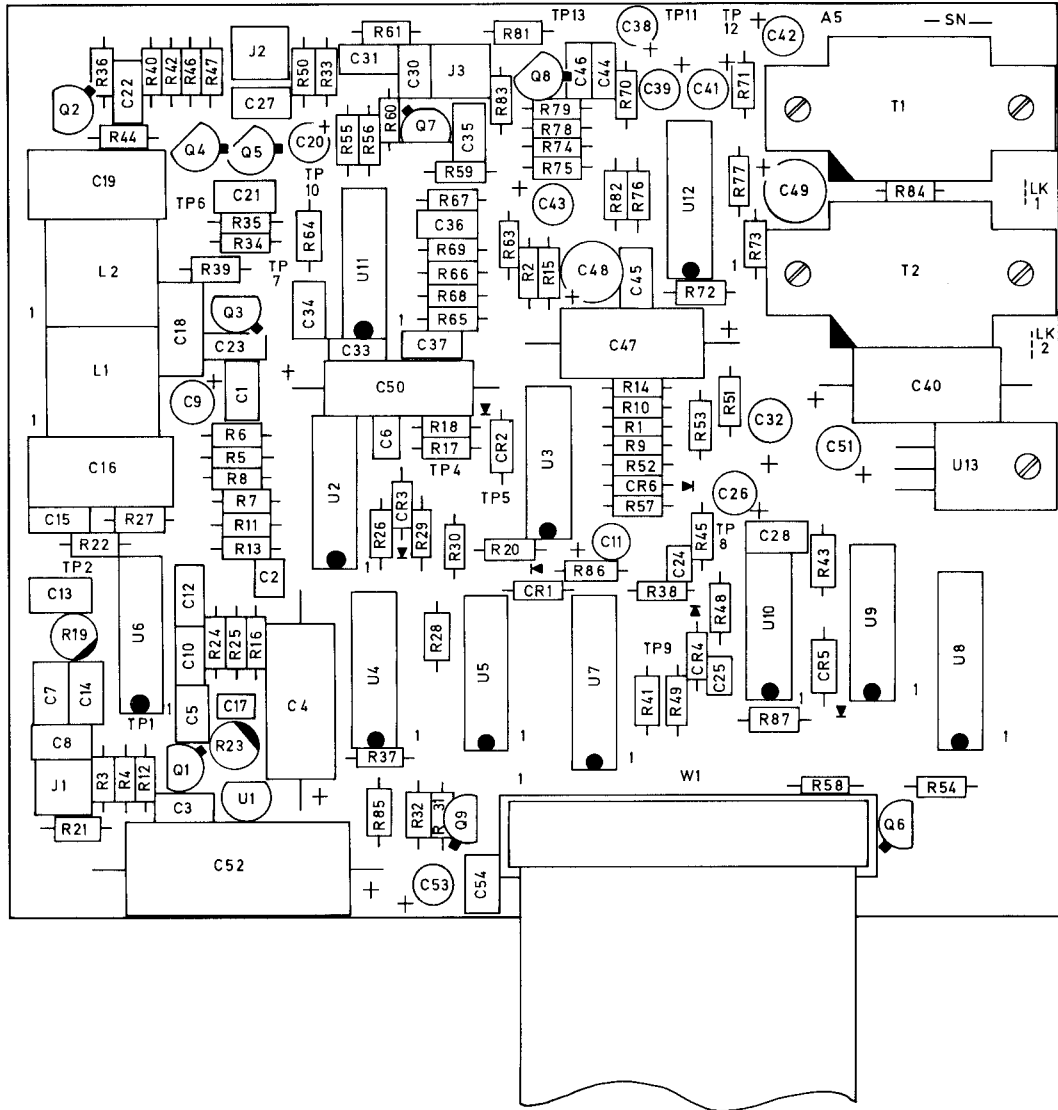

RACAL

| | |
|--------|--------|
| TH1496 | DO8109 |
| 1 | |

Layout : ISB IF/AF Board A5

Fig. App.1.2

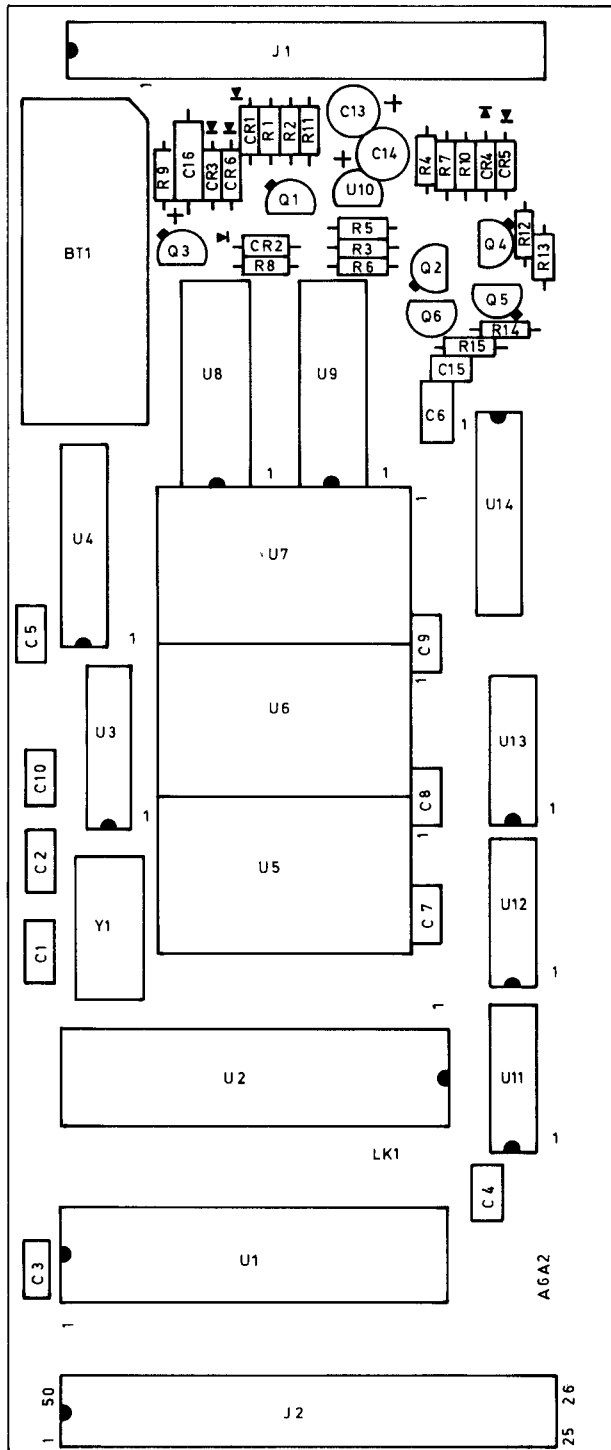

RACAL

| | |
|--------|--------|
| TH1496 | DO8203 |
| 1 | |

Component Layout :
Microcomputer Board A6A2

Fig.6.7

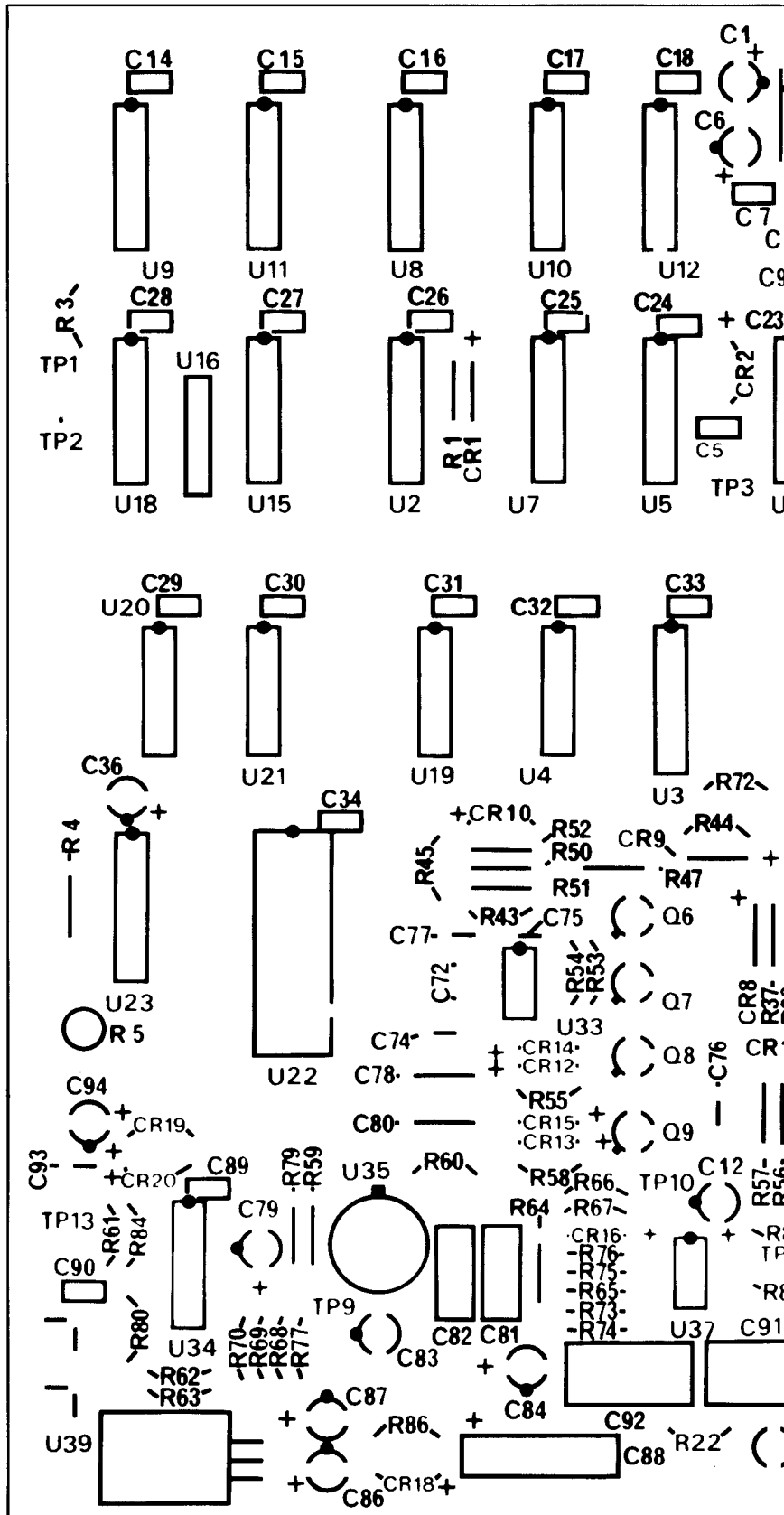

FOR EARLIER VERSIONS SEE APPENDIX 4

RACAL

TH1496 EA80787/4

1

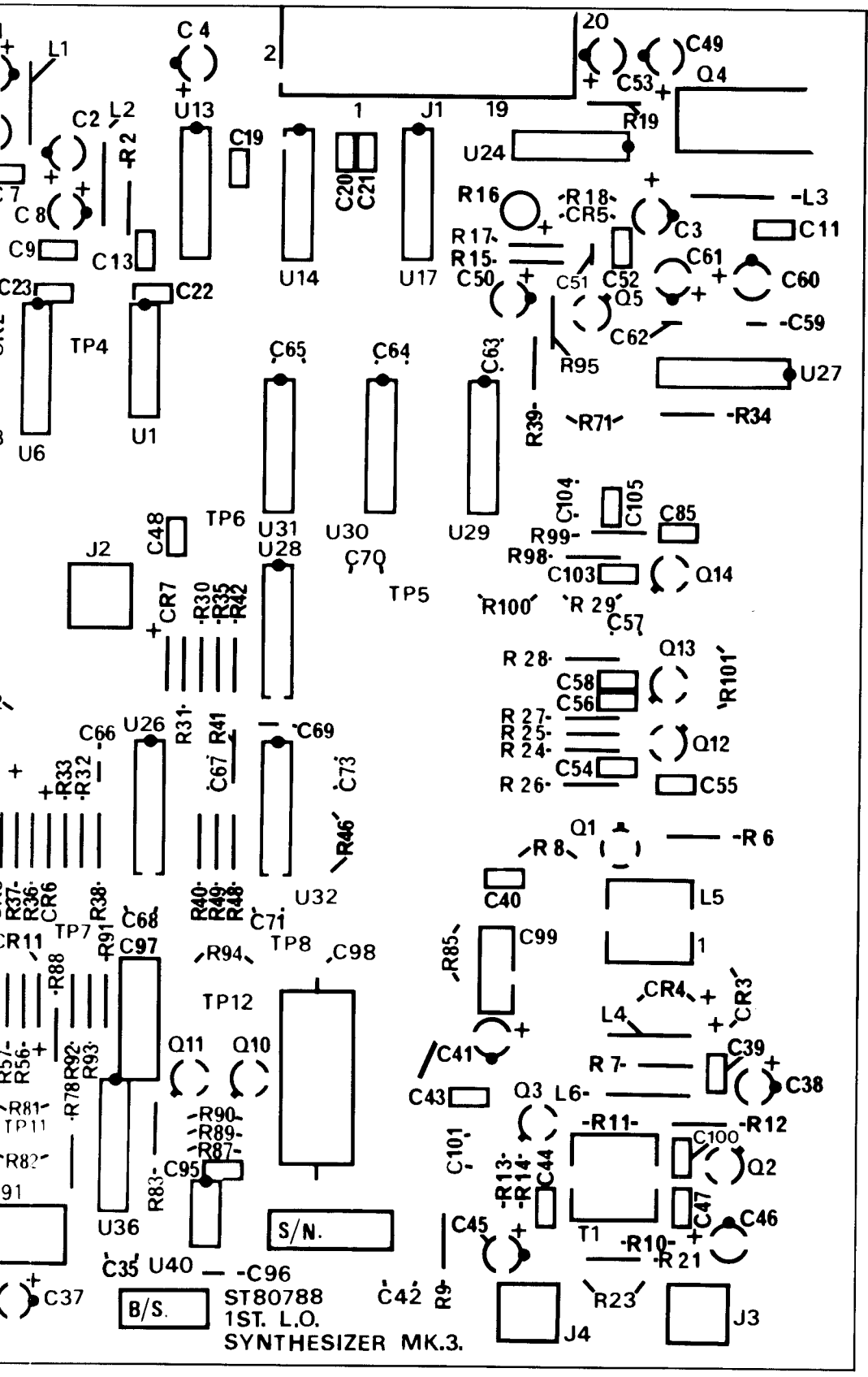

Component Layout:
First LO Synthesizer A7

Fig.6

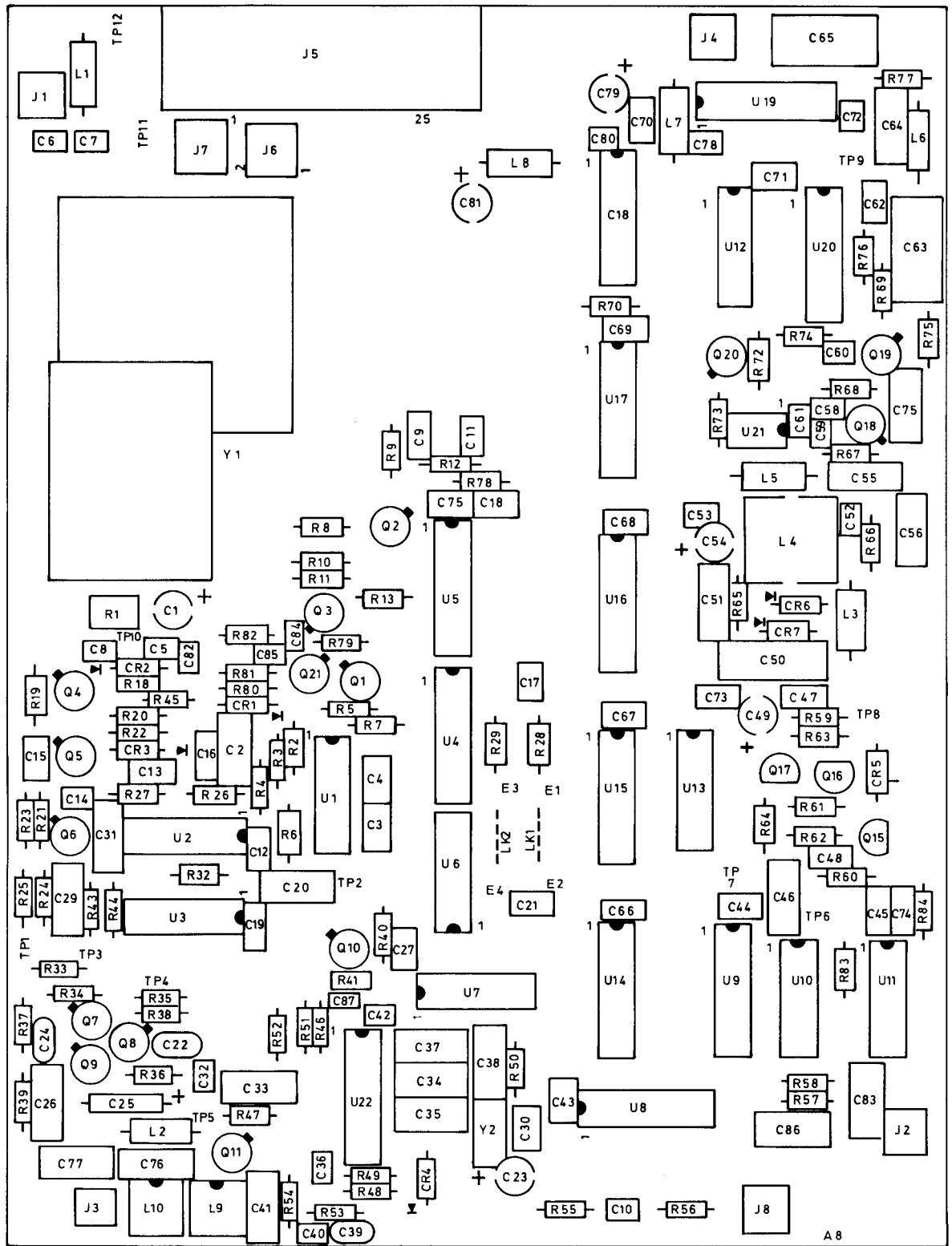

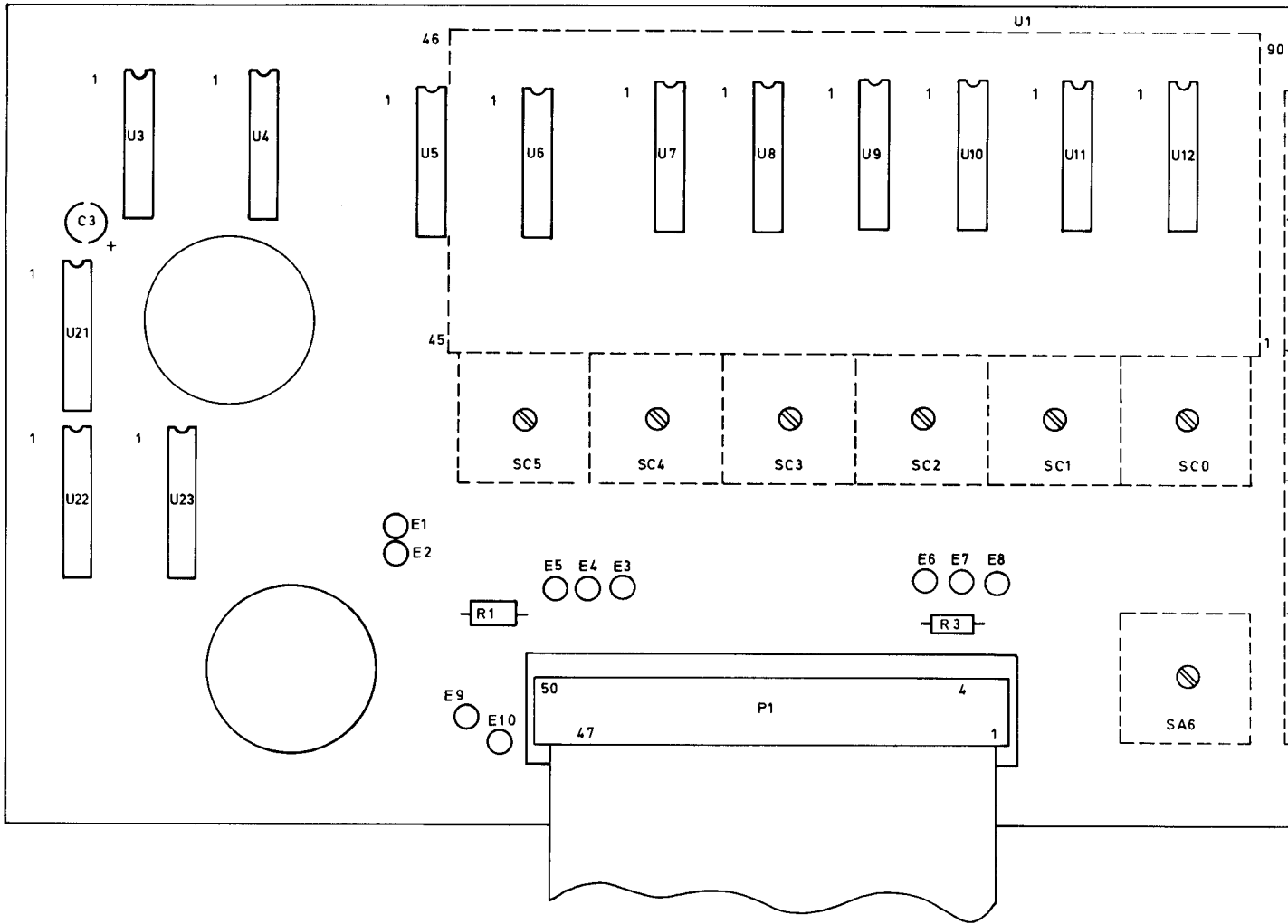

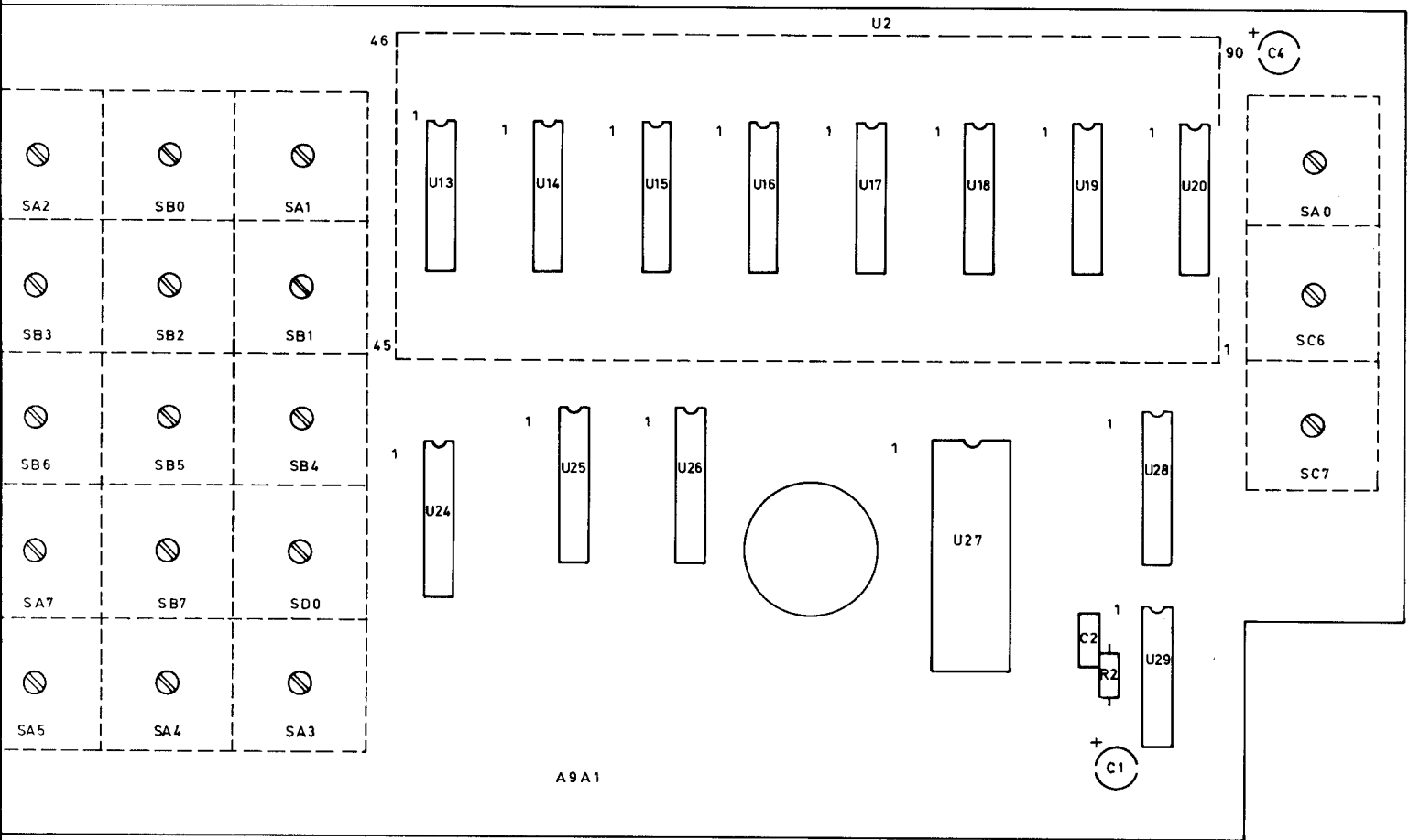

Component Layout: Front Panel Switch and Display Board A9A1 Fig.6.10

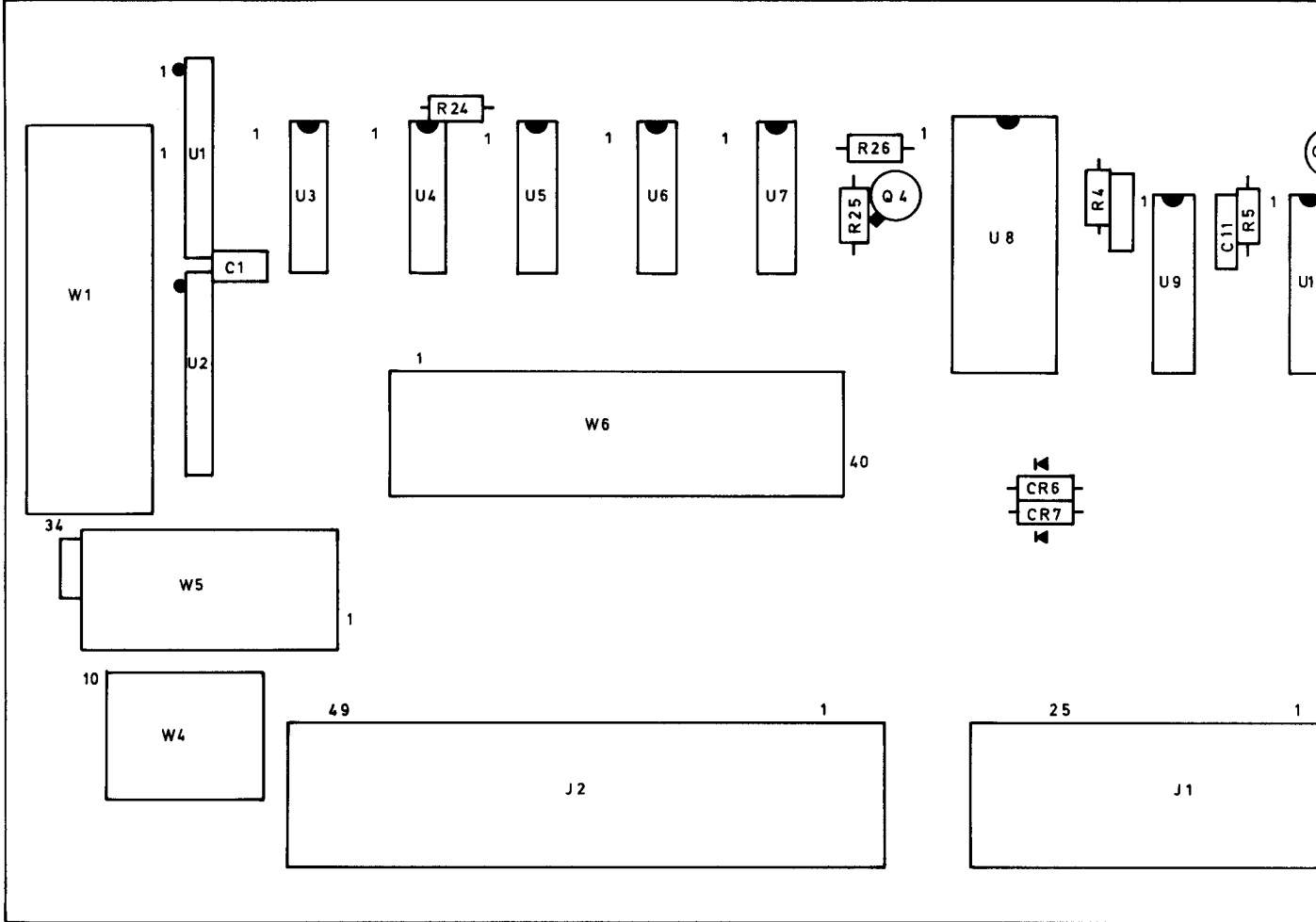

RACAL

TH1496 DO8234

1

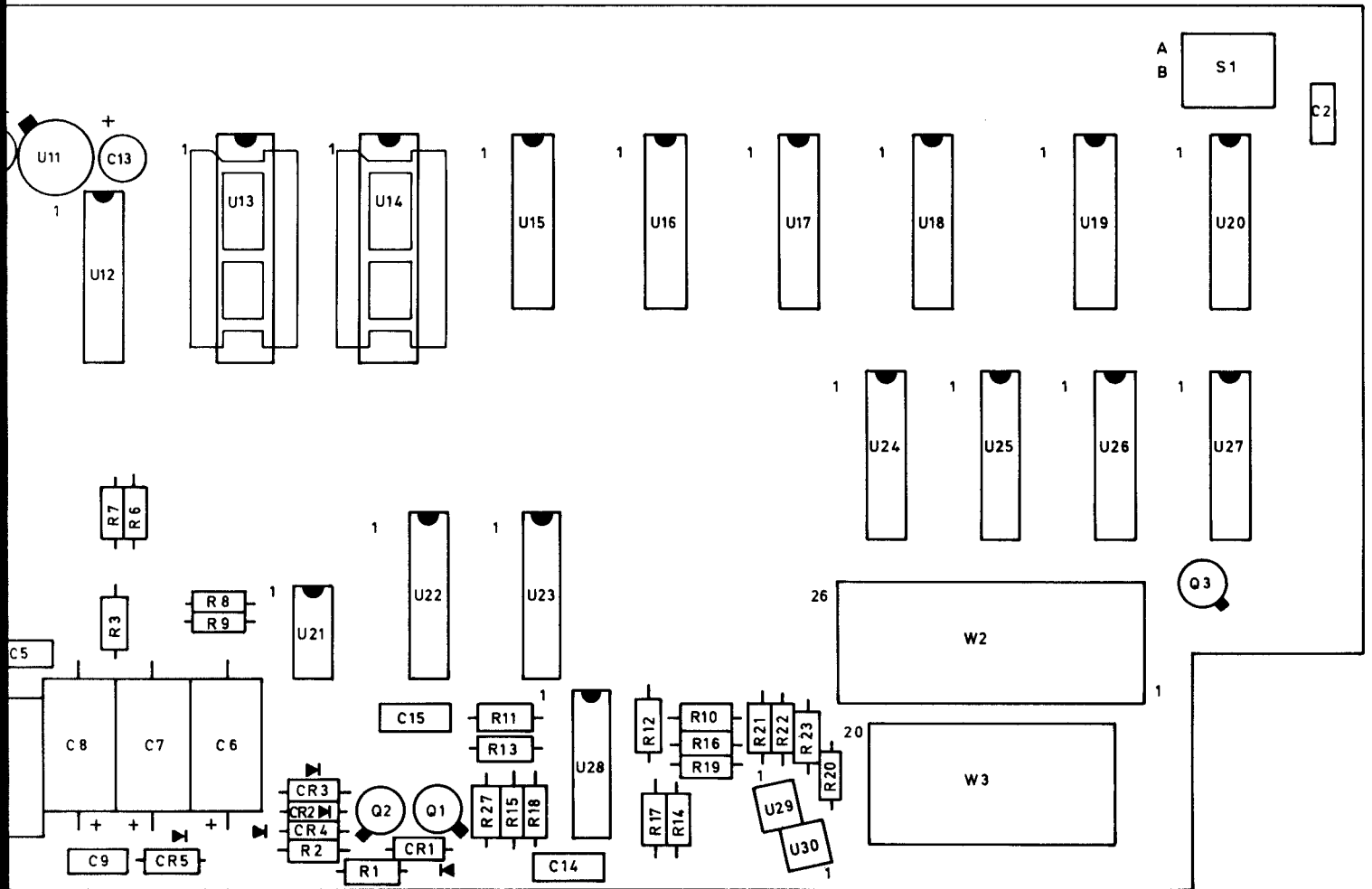

Component Layout :

Front Panel Memory Board A9A2

Fig.6.11

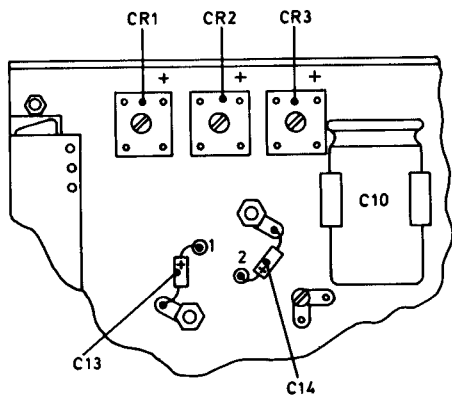
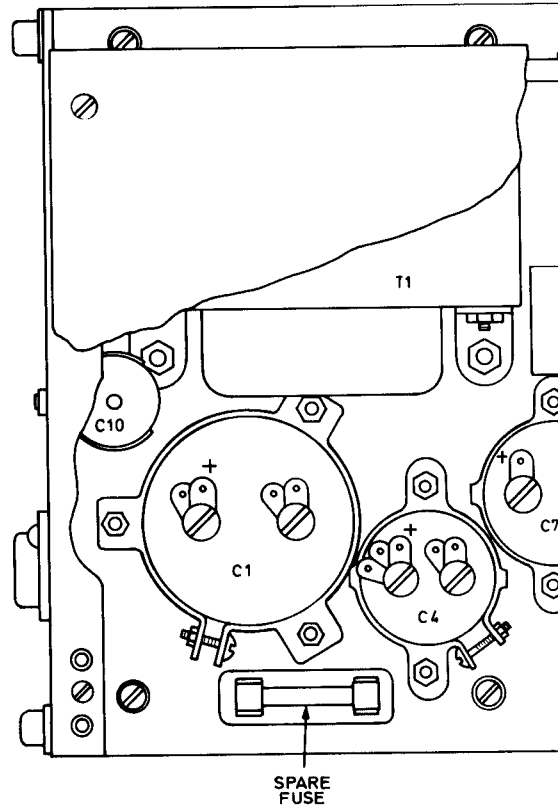
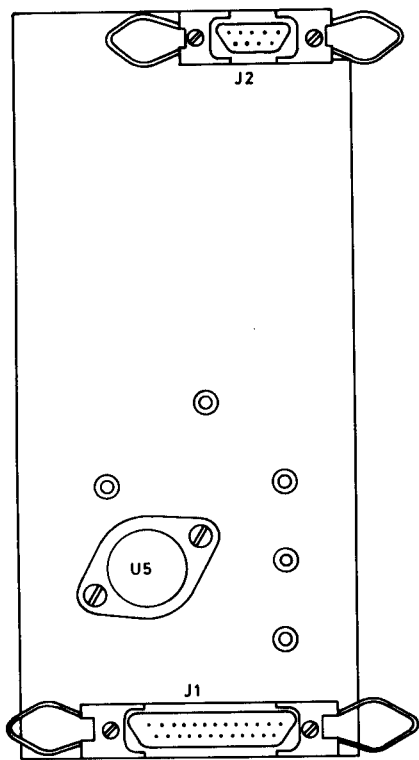

SECTION A-A

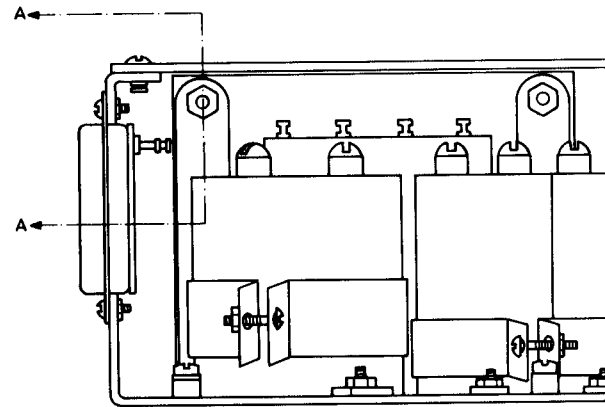

RACAL

TH1496 DO8718

2

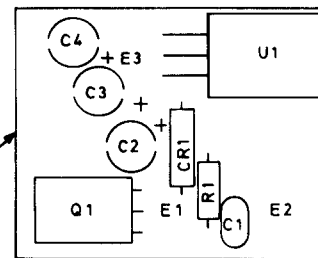
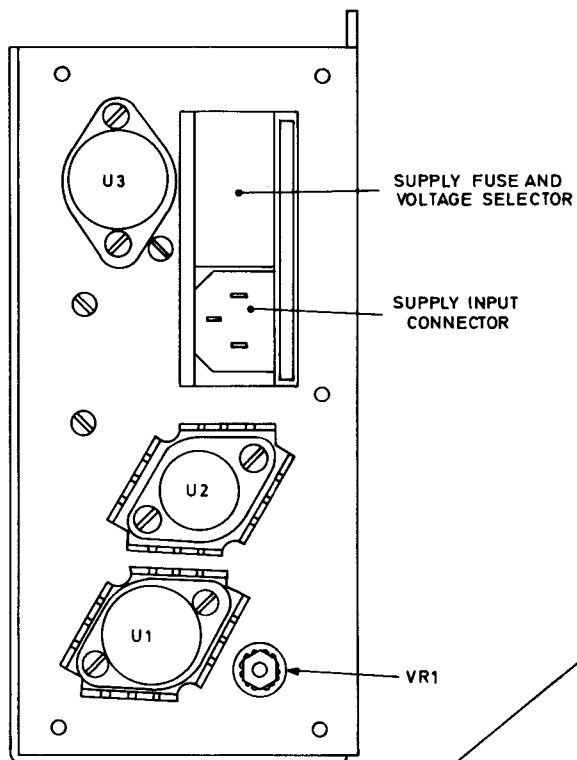
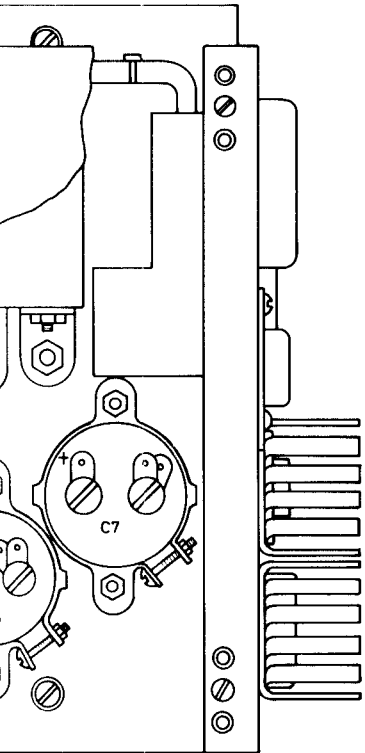

20V REGULATOR BOARD
(A10A2 - B08717)

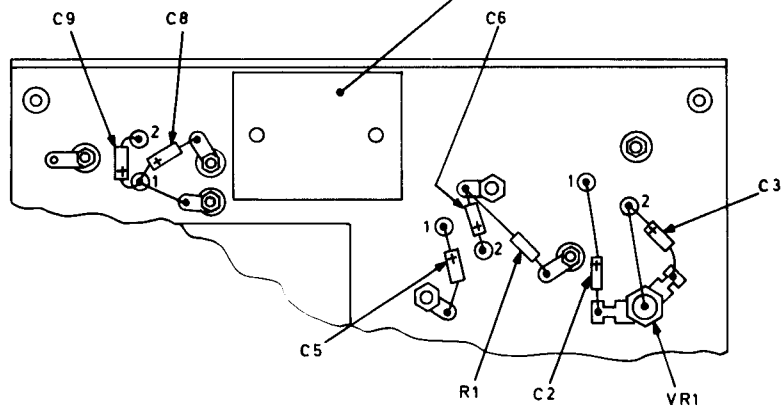
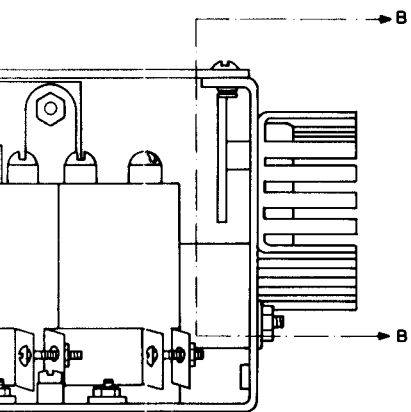

SECTION B-B

**Component Layout:
AC Power Supply Module A10**